

LK-70

Difusor lineal



LK-70-MULTI



LK-70-Curvo



LK-70-C



LK-70-C

31-1-LT

Rejilla lineal de bastidor oculto



31-1-LT

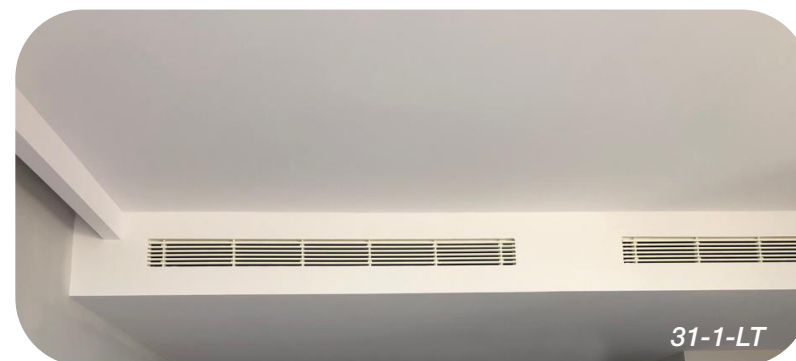

31-1-LT

KOOLAIR

DIFUSORES DE ALTA ESTÉTICA

KOOLAIR

KOOLAIR, S.L. (España)
Calle Urano N° 26
Polig. Ind. N° 2 – La Fuensanta
28936 Móstoles (Madrid)
Tel.: +34 91 645 00 33
E-mail: info@koolair.com
www.koolair.com

DF-LIT-E-4.0

KLR-Curvo

DF-LIT-E-4.0

Difusor lineal oculto

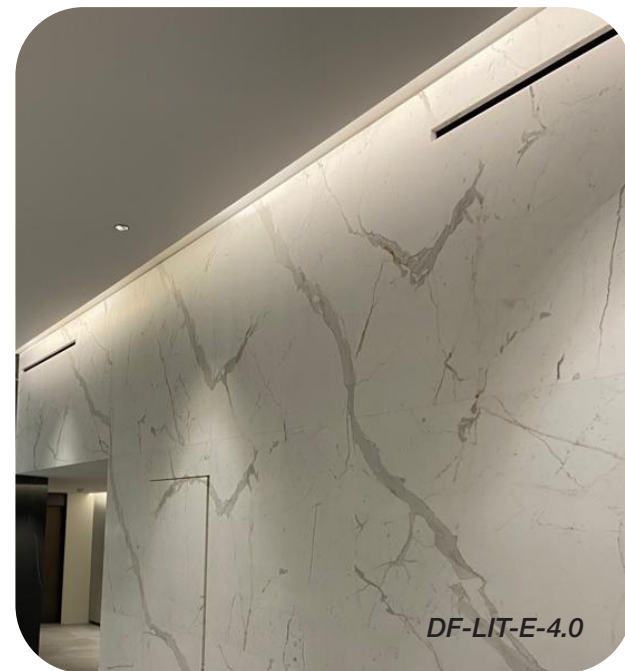
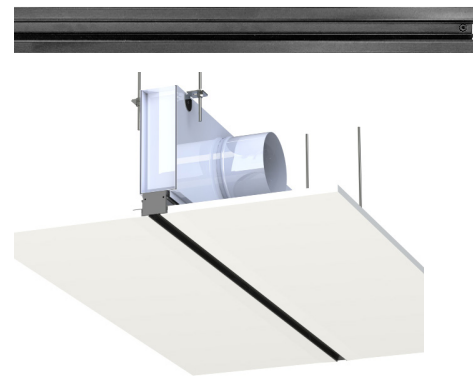

DFRT-I/R

Difusor rotacional de impulsión y retorno

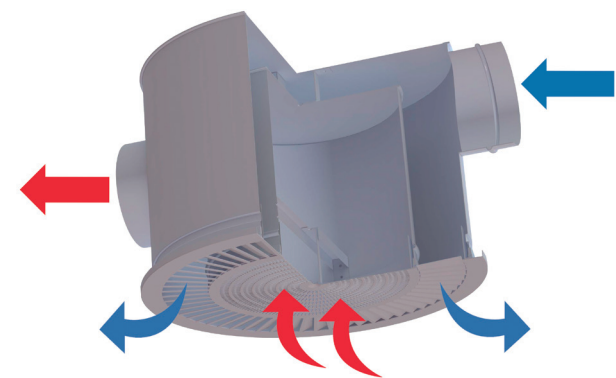

DF-47-NARROW-LT

Difusor lineal oculto

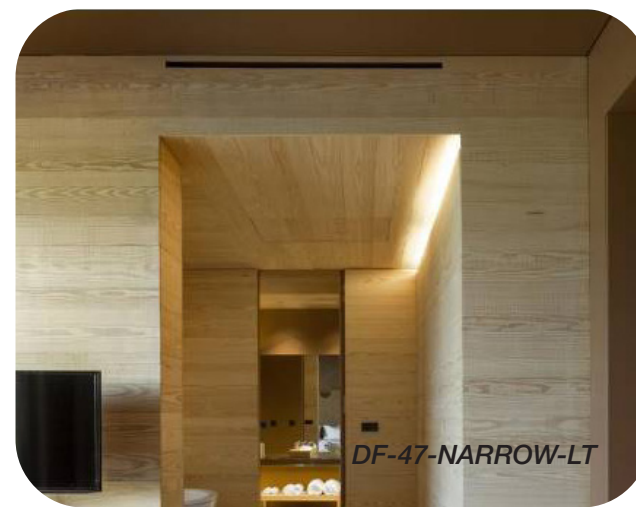

DRLT

Difusor rotacional oculto



DCLT

Difusor circular



KLR

Difusor lineal

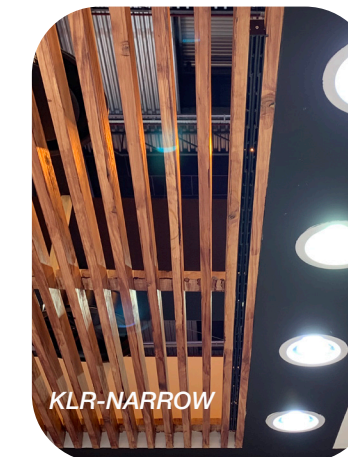

56-FR

Difusor cuadrado oculto

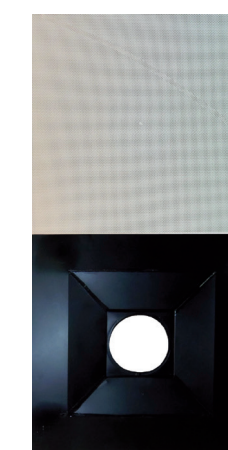

HIDE

Difusor lineal

